

INSTRUCTION MANUAL

FT-207R



YAESU MUSEN CO., LTD.
C.P.O. BOX 1500
TOKYO, JAPAN



Model Feature	A	B	C	D	E
Frequency Coverage	144.0– 147.99 MHz	144.0– 145.9875 MHz	144.0– 147.9875 MHz	144.0– 145.99 MHz	144.0– 147.99 MHz
Preset Frequency	147.00 MHz	145.00 MHz	145.00 MHz	145.00 MHz	147.00 MHz
Synthesizer Steps	10 kHz	12.5 kHz	12.5 kHz	10 kHz	10 kHz
1750 Hz Tone Call	No	Yes	Yes	Yes	Yes
5 kHz Up Switch	Yes	No	No	Yes	Yes
HI/LOW Switch	Yes	Yes	Yes	No	No
Vinyl Case, Battery Pack, Antenna	Yes	Yes	Yes	Yes	Yes

FT-207R MODEL CHART
(All except U.S.A. model)

Copyright © 1979
Yaesu Musen Co., Ltd.
All rights reserved.

Printed in Japan.

No portion of this manual
may be reproduced
without the permission of
Yaesu Musen Co., Ltd.

FT-207R

MICROPROCESSOR CONTROLLED 2 METER BAND FM HAND-HELD TRANSCEIVER

The Yaesu FT-207R^{*} is an all-new microprocessor-controlled FM hand-held transceiver for the 2 meter amateur band. Featuring PLL synthesis in 10 kHz or 12.5 kHz steps (depending on your local requirements), the FT-207R includes four channels of memory, scanning, and a priority channel. Digital display of the operating frequency is provided, and all frequencies are entered from the front panel keyboard.

Transmitter RF power output is 2.5 watts (minimum), and the receiver section provides excellent sensitivity and selectivity. A keyboard lock feature prevents accidental frequency change, and a battery saver switch will disable the digital display, if desired. Memory backup is provided.

The FT-207R comes equipped with a flexible antenna, a vinyl carrying case, a belt clip, and one battery pack. Available options for the FT-207R include the YM-24 Remote Speaker/Microphone, NC-2 Quick Charger/AC Adapter, a handsome leather carrying case, and a compact standard battery charger.

We recommend that you read this manual in its entirety, so as to become better acquainted with the exciting new FT-207R . . . a technological breakthrough from the hams at Yaesu.

SPECIFICATIONS

GENERAL

Frequency coverage:
144–148 MHz
(See Model Chart)

Number of channels:
800

Emission type:
F3

Batteries:
NiCd battery pack

Voltage requirement:
10.8 VDC \pm 10%, maximum

Current consumption:
RX 150 mA (45 mA squelched, display off)
TX 800 mA (HI), 250 mA (LOW)
Memory Backup, approx. 4 mA

Case dimensions:
68 x 181 x 54 mm HWD

Weight (with battery pack):
680 g

RECEIVER

Circuit type:
Double conversion superheterodyne

Intermediate frequencies:
1st IF = 10.7 MHz
2nd IF = 455 kHz

Sensitivity:
0.4 μ V for 20 dB quieting

Selectivity:
 \pm 7.5 kHz at -60 dB

Audio output:
200 mW at 10% THD

TRANSMITTER

Power output:
2.5 watts (min.)/200 mW (HI/LOW)

Deviation:
 \pm 5 kHz

Spurious radiation:
 -60 dB or better

Microphone:
Condenser type, 2 Kohm impedance

Specifications subject to change without notice or obligation.

SEMICONDUCTOR COMPLEMENT

FET:		IC:		Varactor Diode:	
3SK51-03	3	78L05	1	1SV68	1
2SK19GR	1	86022	1	1SV69	4
2SK168D	1	MC1413	1	1T25	1
		MC3357	1		
Transistor:		MC14410	1	Varistor Diode:	
2SA695D	3	TC5082P	1	MV12	1
2SC458D	1	μ PA56C	1	MV103	1
2SC535A	2	μ PC577H	1		
2SC1209D	2	μ PD650-C42	1	Zener Diode:	
2SC1311E	10	μ PD2819C	1	HZ6C-1	1
2SC1815Y	4			HZ9A-1	1
2SC1815GR	1	Silicon Diode:		RD6.8EB	1
2SC2026	2	1S1555	17	WZ056	2
2SC2196	1	1SS53	3		
2SC2352	1	10D1	1	LED:	
2SC2407	1	MI-301	1	LN222RP	1
2SD636R	1			LN322GP	1
JA1350G	2				
				LED Display:	
				5082-7415	1

UNPACKING AND INSPECTION

When you first open your FT-207R packing carton, check the radio for any visible signs of damage. Before installing the battery pack, check all controls and switches for smooth, positive action. If any damage is present, make a complete record of it, and notify the shipping company immediately. Save the foam packing material for possible use at a later date.

TOP PANEL CONTROLS AND SWITCHES

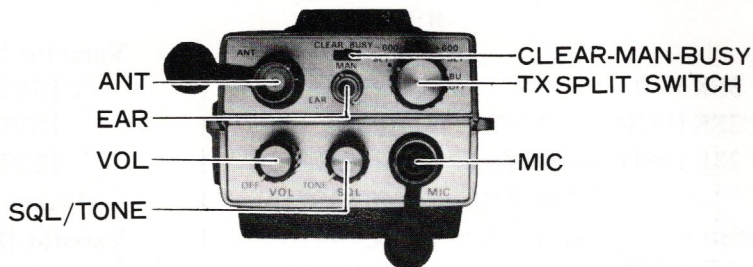

(1) VOL

This is the main volume and power ON/OFF switch for the transceiver. Memory backup with the power off is provided.

(2) SQL/TONE

The squelch control silences the receiver audio until a signal is received. When rotated into the TONE position, this switch will activate the optional Tone Squelch Unit, providing silent monitoring of busy channels.

(3) MIC

This connector accommodates the optional YM-24 Remote Speaker/Microphone.

(4) ANT

The ANT jack is a BNC type connector for quick connection of the antenna.

(5) EAR

This is a miniature phone jack for accommodation of an external earpiece.

(6) BUSY-MAN-CLEAR

This switch selects the STOP mode for the scanner.

(7) TX SPLIT switch

This switch selects the repeater transmit frequency offset desired. In the SIMP position, the transmit and receive frequencies are the same. Shifts of ± 600 kHz and auxiliary splits (\pm SET) can be selected. Rotate this switch fully clockwise to disable the memory backup feature. Do not rotate the TX SPLIT knob with the FT-207R off (backup mode). This will cause the memory channels to be lost.

FRONT PANEL SWITCHES

(1) PTT switch

This switch activates the transmitter.

(2) LED display

The 5 digit LED display indicates the operating frequency.

(3) ON AIR

This indicator lights up during transmission.

(4) BUSY

This indicator lights up when a signal is received by the main squelch.

(5) KEYBOARD

On receive, the keyboard allows frequency input, scanner control, and setting of auxiliary repeater splits. On transmit, the keyboard becomes a two-tone encoder for autopatch or control purposes.

(6) LOCK

This control locks the transceiver on frequency, disabling the keyboard. The purpose of this feature is to prevent accidental frequency change caused by bumping one or more of the keys on the transceiver.

(7) 5 UP/BURST

In FT-207R models equipped for 10 kHz channel steps, this switch shifts the channel frequency up 5 kHz.

In FT-207R models equipped for 12.5 kHz channel steps, this switch activates a manual 1750 Hz tone for accessing repeaters. Press the PTT switch, and set the BURST switch to ON, for as long as the tone is required.

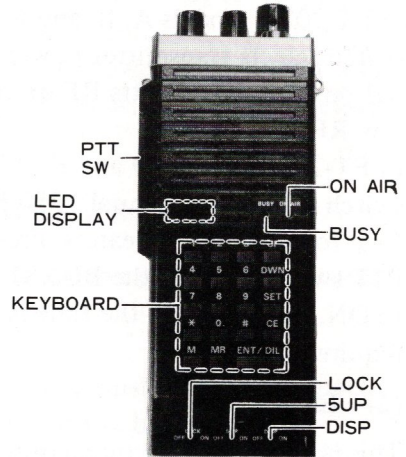

BOTTOM PANEL

(1) POWER HI-LOW/BURST

In FT-207R models A, B, and C, this switch selects transmitter power output powers of 2.5 watts RF or 200 mW RF.

In FT-207R models D and E, this switch activates a manual 1750 Hz tone for accessing repeaters. Press the PTT switch, and set the BURST switch to ON, for as long as the tone is required.

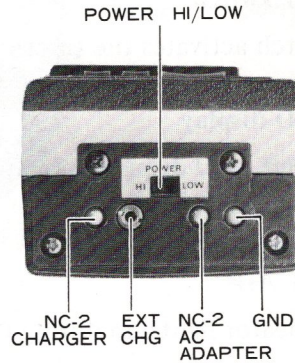

(2) EXT CHG

This jack is used for connection to the external NC-9B/C NiCd charger (option).

(3) QUICK CHARGER CONNECTIONS

These terminals are for use with the NC-2 Quick Charger (option).

(4) AC ADAPTER

These terminals are used for connection to the NC-2 AC Adapter function.



FT-207R/NC-2

BATTERY PACK INFORMATION

The NiCd battery pack is a 10.8 volt 450 mAh pack designed expressly for the FT-207R. We do not recommend the use of other packs; moreover, the FT-207R should never be connected to AC power of any kind, nor DC voltages above exactly 12 volts. These abuses will void any factory warranties.

The following procedure will allow quick changing of battery packs:

1. Use a coin or screwdriver to turn the restraining screw on the rear of the transceiver counterclockwise (CCW) by 90° only.
2. Remove the battery compartment cover.
3. Remove the discharged battery pack, and install the new pack. Be careful to observe the proper polarity of the batteries.
4. Replace the battery compartment cover, and make fast the restraining screw.
5. When operating in a remote area, always be sure to carry at least one extra battery pack, so as not to be without communications in the event of an emergency.

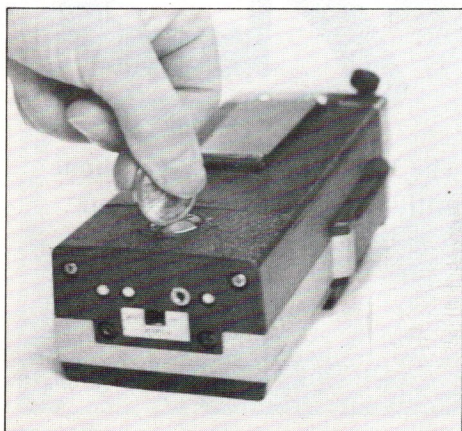

Use a coin to open battery compartment.

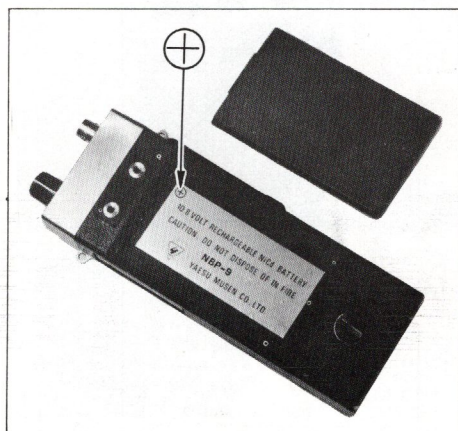

Align ⊕ mark in upper right-hand corner.

ANTENNA CONSIDERATIONS

The FT-207R comes equipped with a flexible, helically wound antenna, which should be sufficient for local work through repeaters, etc. A different type of antenna may, however, be connected to the top panel BNC connector.

The external antenna should have an impedance of 50 ohms, and should be fed with good-quality coaxial cable. If your existing antenna has a connector which is different from the BNC type, consult your dealer regarding purchase of a suitable adapter.



The YM-24 Speaker/Microphone option adds versatility to your Yaesu transceiver.

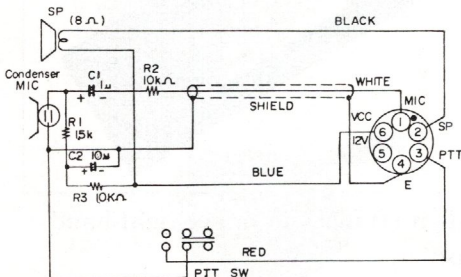

YM-24 Speaker/Microphone Connections

EXTERNAL SPEAKER/MICROPHONE (OPTION)

An external speaker/microphone may be attached through the top panel miniconnector.

The speaker should have an impedance of 2000 ohms. See your Yaesu dealer for details of the YM-24 Remote Speaker/Microphone.

Once installed, the YM-24 may be held close to your ear during reception, allowing you to raise your FT-207R above metal fences and other obstructions. On transmit, hold the microphone near your mouth, and squeeze the switch on the microphone. Release the switch to resume reception.

When hiking, the FT-207R may be mounted to the frame of your backpack, and the YM-24 will then allow TX/RX control. Don't forget, though, to turn the FT-207R off when not using it. It's easy to forget this important step when using the remote speaker/microphone.



Use the convenient belt clip while waiting for calls.



When using the YM-24 Speaker/Microphone, you can raise your FT-207R above obstacles that might ruin reception.

OPERATION

I. Basic Operation

- (1) Preset the controls and switches as follows:

BUSY-MAN-CLEAR	MAN
VOL	OFF
SQL	Fully counterclockwise
TX SHIFT	SIMP
LOCK	OFF
5 UP/BURST	OFF
DISP	ON
- (2) Make certain that the battery pack is correctly installed, and that the antenna has been properly connected.
- (3) Turn the VOL control clockwise out of the click-stop. The digital display will indicate “7.000” meaning 147.000 MHz), and background noise or signals will be heard. Models B, C, and D will display “5.000” (145.000 MHz). Adjust the VOL control for a comfortable listening level.
- (4) When the channel is clear, rotate the SQL control clockwise until the background noise is just silenced. Do not go much beyond this threshold point, or the receiver will not respond to weak signals.
- (5) Squeeze the push-to-talk (PTT) switch to transmit. Release the PTT switch for receiver recovery.

II. Entering Frequencies from the Keyboard (10 kHz models)

- (1) To enter a frequency for operation, the last three digits of the operating frequency must be entered. This frequency must be a multiple of 10 kHz (146.010, 146.020, etc.).
- (2) To enter 146.940 MHz, press “694” on the keyboard. The digital display will now show those digits. Now press the ENT/DIL key. The display will show “6.94”, with the decimal point indicating that the frequency has been entered. You are now operating on 146.940 MHz.
- (3) Let’s try another example. To operate on 146.520 MHz, push “652” and ENT/DIL. You are now operating on 146.520 MHz.

- (4) To reach a frequency which is an odd multiple of 5 kHz (for example, 146.525 MHz), place the 5 UP switch ON. The frequency shift will not be displayed on the digital readout, but the shift will, nevertheless, take place.

III. Entering Frequencies from the Keyboard (12.5 kHz models)

- (1) To enter a frequency in the 12.5 kHz step model, the last five digits of the operating frequency must be entered. This frequency must be a multiple of 12.5 kHz (145.0000 MHz, 145.0125 kHz, 145.0250 MHz, etc.).
- (2) To enter 145.0125 MHz, press “50125” on the keyboard, then ENT/DIL. The digital display will now show “5.012.” as the frequency. The final “.5” digit is not displayed, but the frequency will, indeed, be 145.0125 MHz.
- (3) Let’s try another example. To operate on 145.525 MHz, push “55250” and ENT/DIL. You will now be operating on 145.525 MHz.

IV. Entry and Recall of Memory Channels

- (1) To store a frequency in memory, the desired channel is first entered on the dial, then you press the desired memory channel number (1, 2, 3, or 4), then you press M.
- (2) To program 146.040 MHz in memory channel 1, for example, press “604”, then ENT/DIL, then “1”, then M.
- (3) Now program 146.520 MHz into memory channel 2. Press “652”, then ENT/DIL, then “2”, then M.
- (4) Memory channels 3 and 4 may be programmed in identical fashion.
- (5) To recall a memory channel, push the desired memory channel number (1, 2, 3, or 4) and MR. To recall the frequency stored in step (2) above, press “1” and MR. The digital display will now indicate “6.04 1”, indicating that you are on memory channel 1, 146.040 MHz. If you press “2” and MR, the display will read “6.52 2” per your programming of 146.520 MHz into memory channel 2 in step (3), above.
- (6) For split TX/RX operation using the memory system, first program the desired receive frequency into memory position “0”. For 146.49

MHz, press “649” and ENT/DIL, then “0 M”. Now dial in the transmit frequency. For 146.52 MHz, press “652” and ENT/DIL. Now press “0 MR”. You will transmit on the dial frequency, and receive on the memory 0 frequency. Press ENT/DIL again for transceive operation on the dial frequency.

- (7) You may use both dial and memory frequencies for operation. As an example, program the above two channels into memory. Now, let’s enter 146.880 MHz onto the dial: press “688” and ENT/DIL. To switch to 146.040 MHz, press “1” and MR. To return to 146.880 MHz, press ENT/DIL.
- (8) Rotate the TX SPLIT switch fully clockwise (to the BU OFF position, to the right of the +SET position) to disable the memory backup feature. With the TX SPLIT switch in the ± 600 , \pm SET, or SIMP positions, the memory channels will be held, even though the power switch is turned off. Battery drain for the memory backup is approximately 4 mA.

V. Priority Channel Operation

- (1) First enter into memory all desired memory channels for priority use.
- (2) Now enter another frequency onto the dial. In this example, we will use 146.580 MHz. Press “658” and ENT/DIL.
- (3) Now recall any of the programmed memory channels. In our previous discussion, 146.040 MHz was stored in channel 1. Press “1” and MR to recall 146.040 MHz, channel 1. Now press the # key. The display will indicate “6.58 P”, and every few seconds the display will switch to 146.040 MHz, allowing you to check it for activity.
- (4) If you place the BUSY-MAN-CLEAR switch in the BUSY position, the transceiver will lock on the memory channel if a carrier is present when the channel is checked by the priority search feature. If you place the BUSY-MAN-CLEAR switch in the CLEAR position, the search will stop if the memory channel is clear (no carrier present).
- (5) To choose a different memory channel for use with the priority channel, first press ENT/DIL. Now choose the desired memory channel for recall (for example, press “2” and MR). Now press # again, and the transceiver will switch between the priority channel and memory channel 2.

- (6) When setting up a priority channel, you must first store at least one channel in memory. If you do not, subsequently, dial in a new frequency for priority use, the LAST frequency stored in memory will become the priority channel, when you push #.

VI. Repeater Operation

- (1) Repeater shifts of +600 kHz and -600 kHz are built into the FT-207R. To select these shifts, rotate the top panel TX SPLIT switch to the +600 or -600 positions, respectively.
- (2) To program a split other than ± 600 kHz, the keyboard is again used. For example, let us program a split of 700 kHz. Push "70", then SET. Now rotate the TX SPLIT control to the -SET position. When you press the PTT switch, the digital display will indicate your new transmit frequency, which will be 700 kHz below your receiving frequency. For +700 kHz shift, switch to +SET.
- (3) For a split of 1.6 MHz, press "160" and SET. The TX SPLIT switch may then be set according to your requirements.
- (4) For 12.5 kHz models (B and C), five digits must be entered. For 700 kHz shift, push "07000" and SET. For 1.6 MHz shift, push "16000" and SET. Then select the +SET or -SET frequency, as desired.
- (5) On models B, C, D, and E, the BURST switch will activate a 1750 Hz audio tone for repeater access. Press the PTT switch, and turn the BURST switch ON, for as long as the tone is needed. This is a manual tone generator, so place the BURST switch in the OFF position when you have successfully activated the repeater.

VII. Scanner Operation

- (1) With the BUSY-MAN-CLEAR switch in the MAN position, press the UP or DWN switch to move 10 kHz (12.5 kHz on models B/C) up or down, respectively. If you press the UP or DWN switch for more than $\frac{1}{2}$ second, the scanner will be activated.
- (2) To stop the scan, press the UP, DWN, or PTT switch. If you hit the PTT switch while scanning, no transmission will occur. Release the PTT switch momentarily, then press it again to transmit.

- (3) To scan for a busy channel, place the BUSY-MAN-CLEAR switch in the BUSY position. Now press and hold for a moment the UP or DWN switch. The scanner will search until a channel is found with a signal on it (one strong enough to open the FT-207R squelch). It will stop and hold on this frequency until you activate the scanner again.
- (4) In like fashion, by switching to CLEAR, and activating the scanner, the FT-207R will search until an unoccupied channel is found.
- (5) To scan just the memory channels, first recall any of the memory channels (press 1, 2, 3, or 4 and MR). Now press the UP or DWN button. The four memory channels will be scanned, and you may choose the desired scan stop mode as described in steps (2), (3), and (4), above.

VII. Tone Squelch Operation (Option)

- (1) When the optional tone squelch unit is installed, it may be activated by placing the SQL control in the TONE position.
- (2) When a signal is received which contains a similar subaudible tone squelch signal, the FT-207R squelch will open normally. If the incoming signal does not bear the subaudible tone squelch signal, the receiver will remain silent, but the BUSY lamp will become illuminated. This will alert the operator to the fact that the channel is in use.
- (3) On transmit, a subaudible tone will be superimposed on your voice signal, activating the receiver of other stations equipped with a similar tone squelch system. The tone frequency (both transmit and receive) is factory preset at 77 Hz. See page 27 for details of tone squelch installation and frequency change.
- (4) For autopatch or control purposes, a two-tone encoder can be activated from the keyboard. When you push the PTT switch, the keyboard will function as the two-tone encoder, and you may then dial up the required access codes and the telephone number.

IX. Miscellaneous

- (1) To disable the keyboard, and lock the FT-207R on the frequency

you currently are using, place the LOCK switch in the ON position. This will prevent accidental frequency change.

- (2) To achieve a considerable reduction in battery drain, place the DISP (Display) switch in the OFF position. The display will remain on for about two seconds, then it will automatically go off. If you touch any of the keys on the keyboard (for example, to recall a memory channel, scan, or program a new frequency), the display will switch off about two seconds after your last key entry.
- (3) To select different transmitter output powers, the bottom panel POWER switch may be set at HI (2.5 watts output) or LOW (200 mW output). Models D and E do not have this facility, as the switch is used for the tone calling feature.

X. Error Modes

- (1) If you attempt to program a frequency incorrectly (for example, by pushing "155" and ENT/DIL), the display will indicate "E" to tell you that an error has been made. Push CE (Clear Entry) for return to the previous frequency.
- (2) If you program a repeater shift outside of the amateur band (for example, +600 kHz shift at 147.99 MHz), the display will indicate E when the PTT switch is pushed. No transmission will occur under this condition.
- (3) If you push the M key without first pressing the ENT/DIL key, the display will show E. Again push CE to return to the previous frequency.

CIRCUIT DESCRIPTION

The block diagram and circuit description should provide you with a better understanding of the FT-207R circuitry. Please refer to the schematic diagram for specific component details.

RECEIVER

The signal from the antenna is passed through a low-pass filter and diode switch D_{101} (**MI301**) for delivery to the receiver strip.

The 144–148 MHz signal is amplified by RF amplifier Q_{101} (**2SC2026**) and fed to the first mixer, where the RF signal is mixed with a 133.3–137.3 MHz local signal from the Voltage Controlled Oscillator (VCO), producing a 10.7 MHz first IF. The IF signal is then passed through a selective filter network at XF_{101} and XF_{102} , and then amplified by Q_{103} (**2SC1311E**). The amplified signal is then delivered to the second mixer, where the 10.7 MHz signal is mixed with a 10.245 MHz local signal, resulting in a 455 kHz second IF. The second mixer and second local oscillator are both located on Q_{104} (**MC3357**).

The second IF signal is then passed through another selective filter, CF_{101} , and amplified by Q_{105} (**2SC1815Y**). The signal is then delivered to Q_{104} , where one section acts as a limiter to remove any amplitude variations in the IF signal. A further section acts as a discriminator, which produces an audio output in response to a corresponding frequency shift in the IF signal.

The audio signal is then amplified by Q_{106} (**2SC1815Y**), Q_{107} (**2SA695D**), and AF PA Q_{108} (**2SC1209D**) and Q_{109} (**2SC695D**), which deliver 200 mW of audio to the front panel speaker.

When no carrier is present in the 455 kHz IF, the high frequency noise at the discriminator output is amplified by a noise amplifier, located on Q_{104} . This signal drives a switch at Q_{104} which grounds the base of audio amplifier Q_{106} , thus quieting the receiver. When a carrier is present in the 455 kHz IF, the noise is removed from the discriminator output, and the

receiver recovers normal operation. VR_1 sets the squelch threshold sensitivity. Q_{110} (**2SC1311E**) also acts as a switch to activate the SCAN STOP function of the Central Processing Unit (CPU).

TRANSMITTER

The transmitter produces a frequency modulated signal. The audio signal from the microphone or two-tone encoder Q_{404} (**MC14410**) is amplified by Q_{201} (μ **PC577H**) and filtered to remove signal components above the speech range. The speech signal is then applied to phase modulator varactor diode D_{201} (**1SV68**), which varies the frequency of 10.7 MHz crystal oscillator Q_{203} (**2SC1311E**).

The IF signal is then fed to mixer Q_{204} (**3SK51**), where the 10.7 MHz FM signal is mixed with a 133.3–137.3 MHz local signal from the VCO, resulting in a 144–148 MHz signal. The RF signal is passed through a selective bandpass filter, amplified by buffer amplifier Q_{205} (**3SK51**), and delivered to the amplifier chain, consisting of Q_{206} (**2SC2026**), Q_{207} (**2SC2407**), and Q_{208} (**2SC2196**). The resulting 2.5 watt RF signal is passed through diode switch D_{101} and a low pass filter to the antenna.

HETERODYNE OSCILLATOR

The heterodyne signal at 133.3–137.3 MHz for the transmit and receive mixers is generated by a PLL (Phase Locked Loop) circuit.

The VCO oscillator, Q_{301} (**2SK19GR**) generates a signal at 133.3–137.3 MHz. The oscillator frequency is controlled by varactor diode D_{301} (**IT25**), which varies the capacitance of the oscillator tuned circuit in accordance with the control voltage supplied from phase comparator Q_{307} (μ **PD2819C**). The output signal from Q_{301} is amplified by buffer amplifier Q_{302} (**3SK51**), and delivered to the transmitter and receiver mixers.

A portion of the output from Q_{302} is fed through buffer amplifier Q_{303} (**2SK168D**) to PLL mixer Q_{304} (**2SC535A**), where the VCO signal is mixed with the 132.3 MHz PLL local signal delivered from Q_{308} (**2SC535A**), producing a 1–5 MHz PLL IF signal. In the 5 UP position, the PLL local

frequency is 132.305 MHz, and diodes D₃₀₂ and D₃₀₃ (1SS53) are used to select the desired local crystal.

The PLL IF signal is amplified by Q₃₀₅ and Q₃₀₆ (2SC1815Y), and the amplified signal is then fed to Q₃₀₇ (μ PD2819C). One section of Q₃₀₇ functions as a 5.76 MHz crystal oscillator. This signal is then divided into a 10 kHz reference signal. The phase comparator function of Q₃₀₇ then compares the phase of the PLL IF signal with that of the PLL reference signal, and any difference in phase is converted into an error-correcting voltage. This voltage is fed to varactor diode D₃₀₁ (1T25), which changes the output signal phase to lock with that of the reference signal. The control voltage is also used to tune the transmitter bandpass filter to the frequency in use, thus providing optimum spurious attenuation.

When the VCO is locked, the constant voltage at pin 7 of Q₃₀₇ is fed to Q₂₀₉ (2SC1311E), causing it to conduct; in turn, Q₂₁₀ and Q₂₁₁ (2SC1311E) are biased so as to provide operating voltage to the transmitter or receiver stage, depending on the status of switches Q₂₁₂ (2SA695D) and Q₂₁₃ (2SC1209D). When the VCO is unlocked, the switching chain is biased to remove operating voltage from the TX and RX stages, preventing normal operation until VCO lock is achieved.

PLL CONTROL SECTION

The PLL Control Unit features a 4 bit microprocessor chip, Q₄₀₁ (μ PD650C). The reader is referred to the block diagram of the PLL Control Unit for explanation of the functions of the CPU. A full description of every logic state is well beyond the scope of this manual.

MAINTENANCE AND ALIGNMENT

The FT-207R has been carefully aligned and tested at the factory prior to shipment. The solid state discrete devices and integrated circuits used in the FT-207R should provide many years of trouble-free service, if the transceiver is not abused and if routine maintenance is carried out.

Periodic cleaning of the interior of the transceiver may be required if the unit is used in a dusty environment. A vacuum cleaner may be used to remove loose dirt, while a small brush will help in dislodging caked dirt. The exterior may be wiped with a damp cloth as needed.

Should reduced power output or degraded receiver sensitivity indicate the need for alignment, we recommend that the transceiver be returned to your Yaesu dealer, as the test equipment and expertise required to align the FT-207R can be obtained there. Any attempt to align this transceiver without the proper equipment and knowledge may result in seriously degraded performance.

ALIGNMENT

Equipment Required:

- (1) Signal generator good to 150 MHz
- (2) Sweep generator for 10.7 MHz
- (3) Audio voltmeter
- (4) Audio oscillator
- (5) Deviation meter
- (6) Dummy load/wattmeter (50 ohms, 150 MHz, 5W)
- (7) Oscilloscope good from DC to 10 MHz
- (8) Frequency counter good to 150 MHz
- (9) VTVM or VOM

REMOVAL OF TRANSCEIVER CASE

- (1) Remove screws A and B in Fig. 1, using a Phillips screwdriver of the proper size. Carefully remove the back panel of the transceiver.
- (2) Remove screws C and D in Fig. 2. The front panel may now be carefully removed. Be certain not to put undue strain on the interconnection wires.

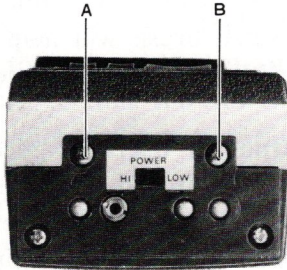

Figure 1

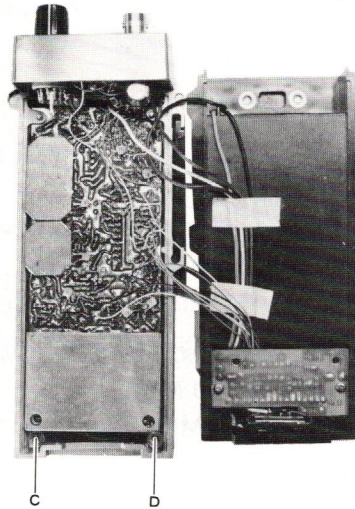

Figure 2

I. PLL Alignment

A. VCO Alignment

1. Connect the VTVM (1V range) to gate 2 of Q_{204} .
2. Peak T_{301} for a maximum indication on the VTVM (nom. 350 mV RMS).
3. Connect the VTVM (10V range) to the exposed lead of R_{340} (see inset).
4. Adjust the core of L_{301} for a reading of exactly 3.0 volts on the VTVM.

B. Local Frequency Adjustment

1. Connect an oscilloscope to pin 14 of Q_{307} .
2. Adjust the core of T_{302} for maximum deflection on the scope display.
3. Connect the frequency counter to gate 2 of Q_{204} .
4. Switch the 5 UP switch OFF.
5. Adjust TC_{301} for a reading of exactly 135.300 MHz on the counter.
6. Now switch the 5 UP switch ON.
7. Adjust TC_{302} for a reading of exactly 135.305 MHz on the counter.

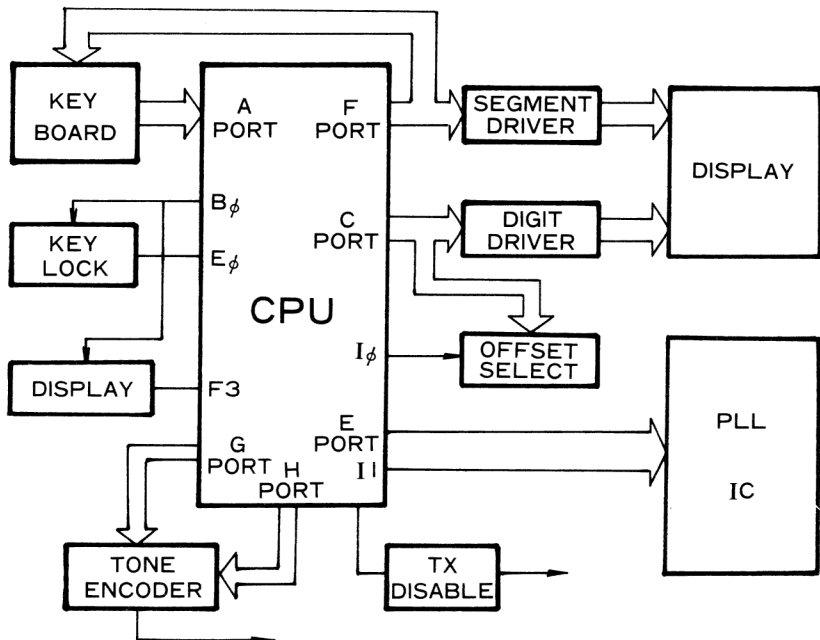

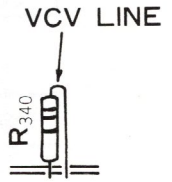
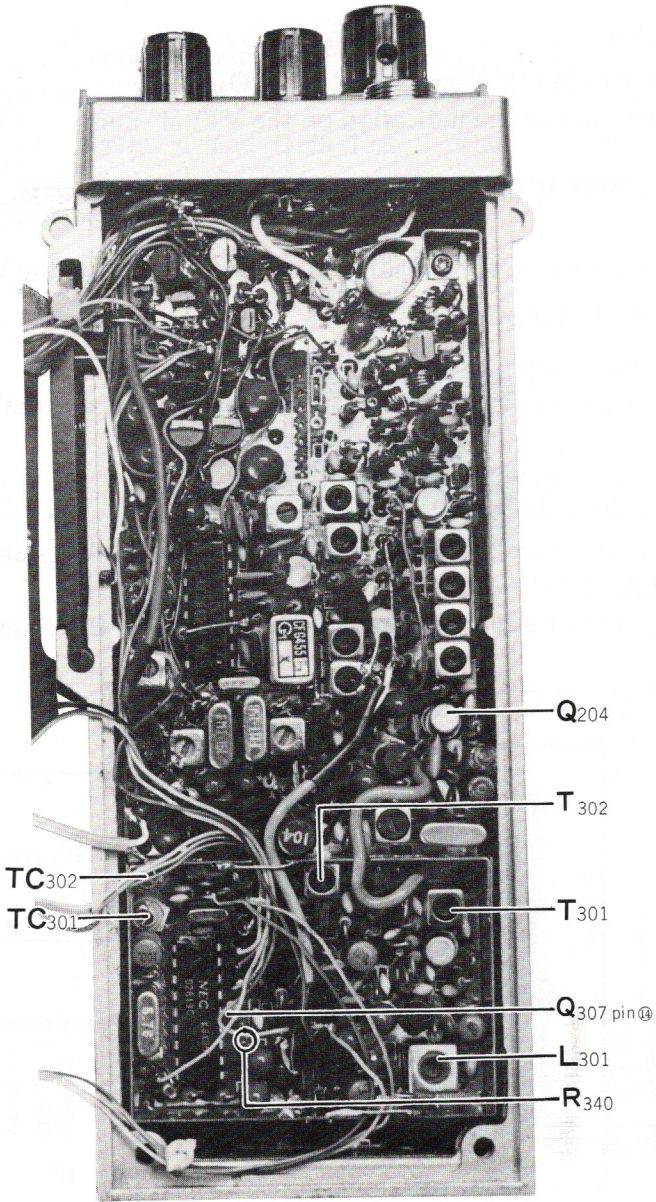

PLL SECTION ALIGNMENT POINTS

II. Receiver Alignment

A. 10.7 MHz IF Alignment

1. Connect a sweep generator to the base of Q_{102} , and connect the diode detector of an oscilloscope to pin 16 of Q_{104} .
2. Set the sweep output center frequency to 10.7 MHz.
3. Adjust T_{105} , T_{106} , and T_{107} until the pattern shown in Figure 3 is obtained.
4. Remove the sweep generator. Connect the VTVM to pin 2 of Q_{104} . Check the local injection level, which should be 25mV RMS.

B. RF Amplifier and 455 kHz IF Alignment

1. Connect the signal generator to the antenna jack, and set its output to 146.000 MHz with 1000 Hz modulation input at 3.5 kHz deviation. Set the FT-207R to 146.000 MHz.
2. Connect the oscilloscope to the speaker terminal.
3. Apply the output of the signal generator, and adjust T_{101} , T_{102} , T_{103} , and T_{104} for a pure, noise-free sine wave display on the scope.

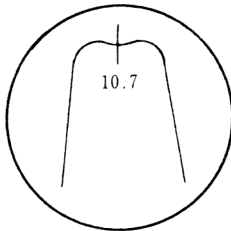
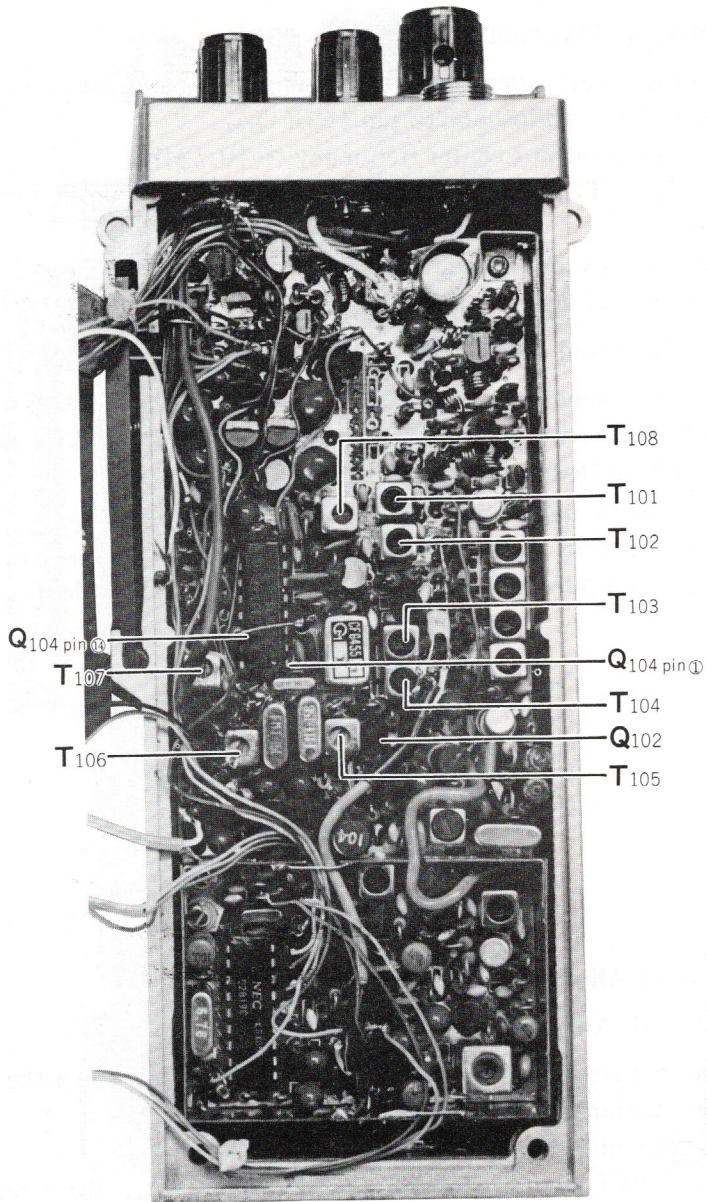

Figure 3

III. Transmitter Alignment

A. 10.7 MHz IF Alignment

1. Connect the frequency counter to gate 1 of Q_{204} . Connect the dummy load/wattmeter to the ANT jack.
2. Ground the microphone input lead.
3. Close the PTT switch, and adjust the core of L_{202} for a reading of 10.7 MHz \pm 200 Hz on the counter.



RECEIVER SECTION ALIGNMENT POINTS

B. Final Amplifier Bandpass Filter Alignment

1. Connect the dummy load/wattmeter to the ANT jack. Set the HI/LOW switch to HI.
2. Connect the VTVM (1V range) to the emitter of Q_{206} .
3. Close the PTT switch, and adjust the cores of T_{201} , T_{202} , T_{203} , and T_{204} for maximum deflection of the VTVM. Now remove the VTVM.
4. Close the PTT switch, and observe the power output on the wattmeter. Slightly open or compress the turns of L_{203} , L_{204} , L_{205} , L_{206} , L_{207} , L_{208} , and L_{212} , and adjust TC_{201} , for maximum power output.
5. Check the power output from 144.01 to 147.99 MHz to be certain that the power output does not fall more than 10% over this range. Repeat steps 3 and 4, as necessary, to achieve uniform power output.

C. Deviation Setting

1. Set up the FT-207R and test equipment as shown in Figure 4.
2. Apply a 1000 Hz tone at a level of 25 mV to the microphone input line.
3. Close the PTT switch, and adjust VR_{201} for a deviation of 4.5 kHz on the transmitted signal.

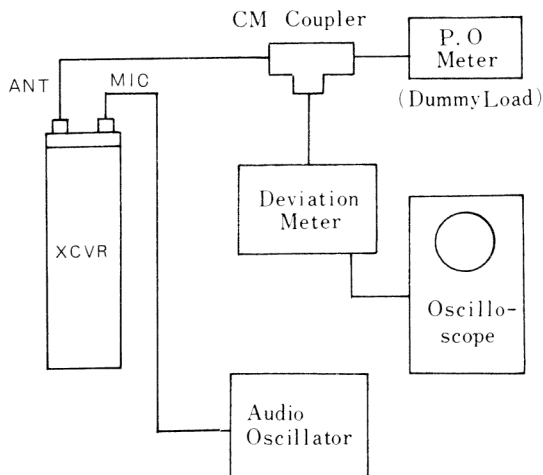
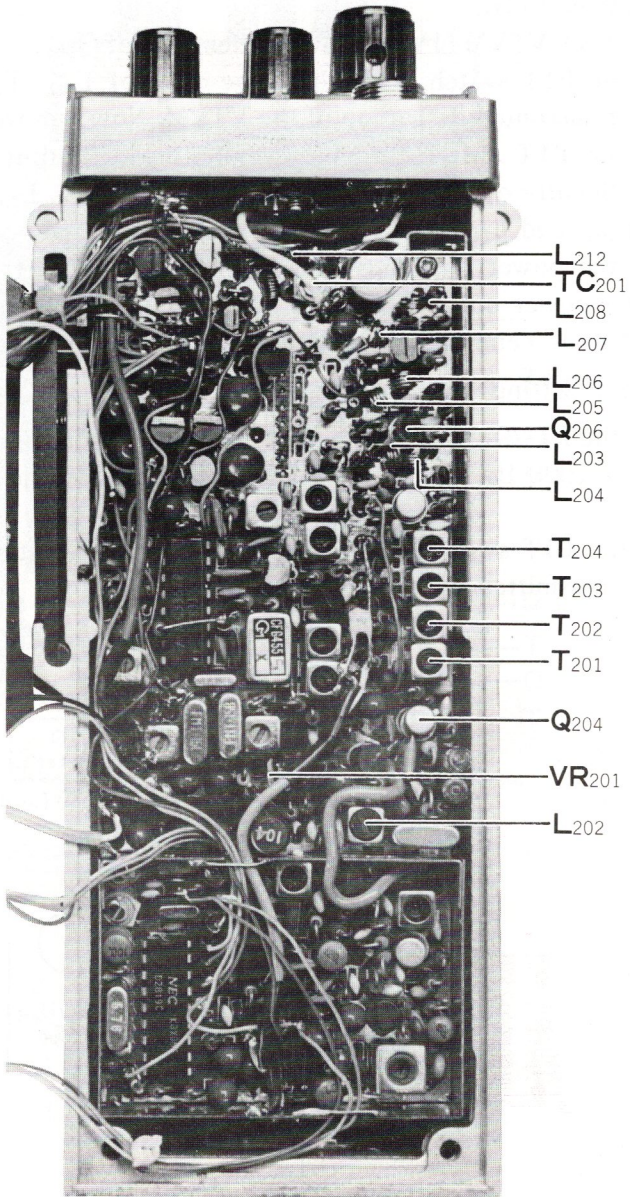
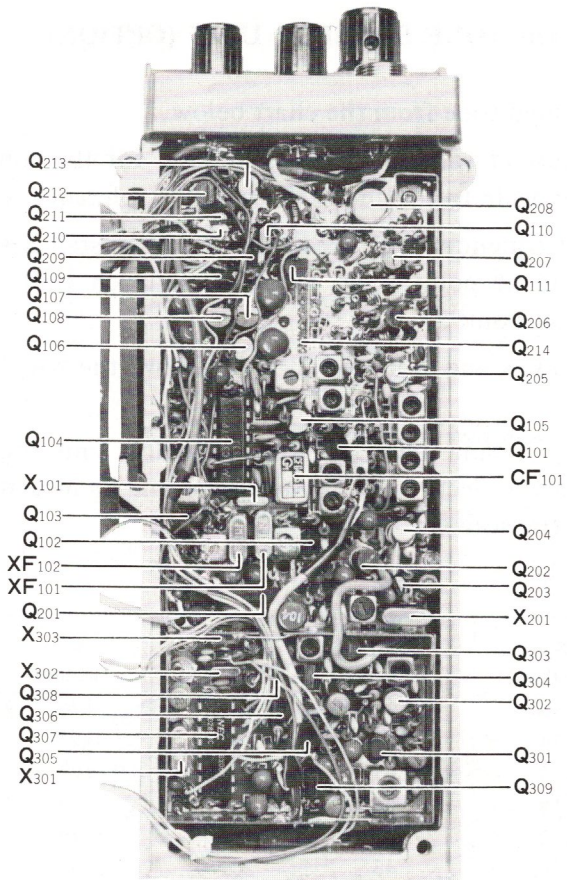

Figure 4



TRANSMITTER SECTION ALIGNMENT POINTS



MAIN UNIT

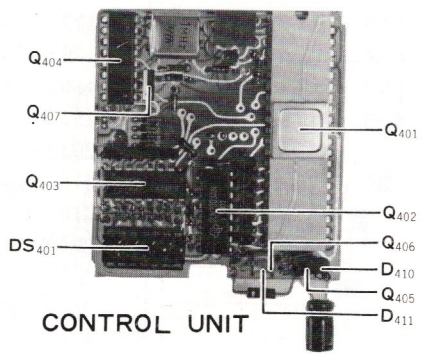

CONTROL UNIT

INSTALLATION OF TONE SQUELCH UNIT (OPTION)

- (1) Select the desired tone from the chart below.
- (2) Install the correct values of R_{501} and R_{502} for the tone frequency desired. Refer again to the chart. Use only 1% tolerance resistors.
- (3) If the tone frequency is 127.3 Hz or higher, install a solder bridge across the foil at point 1 on the Tone Squelch Unit, and another solder bridge at point 2.
- (4) Remove screws A and B in Fig. 5, and remove the back cover of the transceiver.
- (5) Refer to Fig. 6, and plug the Tone Squelch Unit into the wiring harness as shown. Secure the circuit board and its insulator as shown. Close up the transceiver.

TONE Frequency (Hz)	R_{501} (kOhms)	R_{502} (kOhms)	TONE Frequency (Hz)	R_{501} (kOhms)	R_{502} (kOhms)
67.0	180	0.442	127.3	196	3.92
71.9	154	2.67	131.8	182	4.53
77.0	133	3.65	136.5	169	4.87
82.5	118	1.00	141.3	162	0.28
88.5	102	1.43	146.2	150	1.58
94.8	88.7	1.43	151.4	140	1.33
100.0	80.6	0.402	156.7	130	1.96
103.5	75	0.619	162.2	121	2.15
107.2	69.8	0.681	167.9	113	1.91
110.9	64.9	0.953	173.8	107	0.261
114.8	60.4	1.07	179.9	100	0.110
118.8	56.2	1.20	186.2	93.1	0.348
123.0	52.3	1.24	192.8	86.6	0.562
			203.5	76.8	1.43
			210.7	71.5	1.47
			218.1	68.1	0.013
			225.7	63.4	0.200
			233.6	59	0.374
			241.8	54.9	0.511
			250.3	51.5	0.619

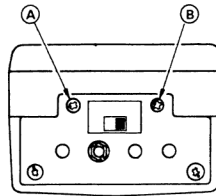

Fig. 5

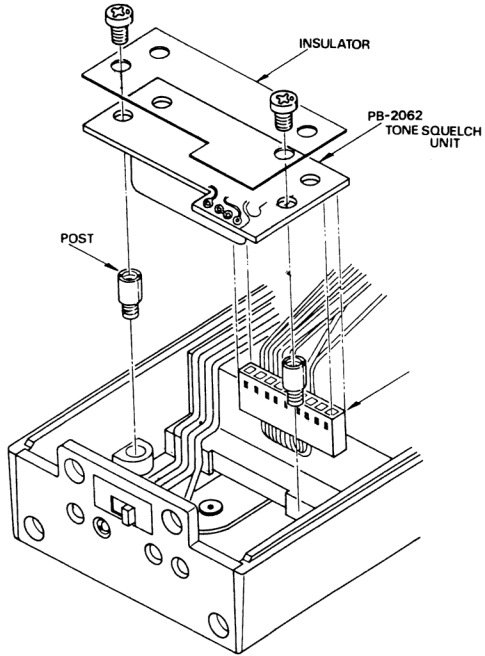

Fig. 6

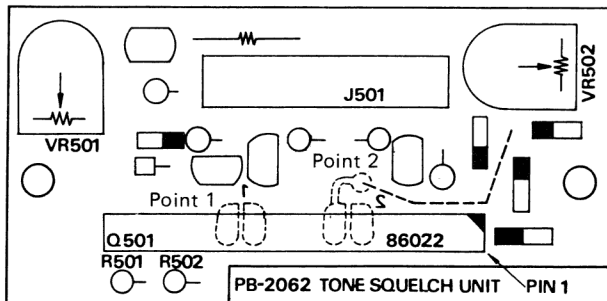
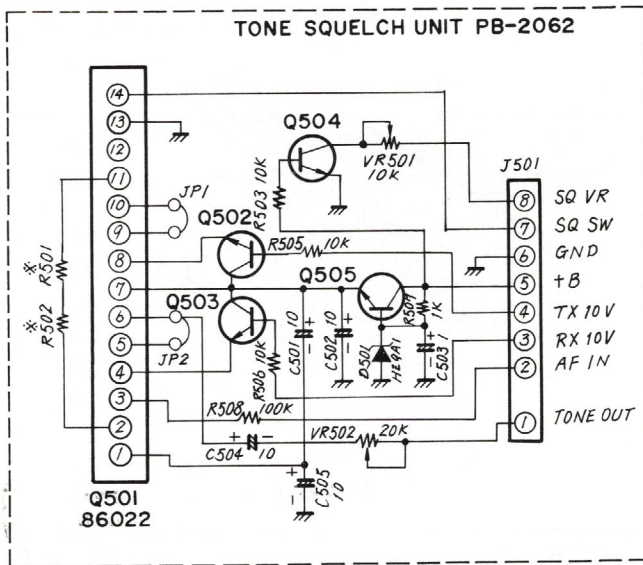
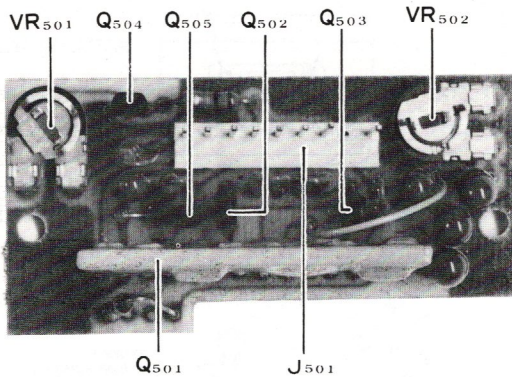

Fig. 7

Viewed from
component side



1. ALL TRANSISTORS ARE 2SC1311 E.
2. INSTALL JUMPERS JP1/JP2 FOR TONE FREQUENCIES ABOVE 125Hz.
3. SEE OTHER TABLE FOR VALUES OF R501 AND R502 FOR DESIRED TONE FREQUENCY.

TONE SQUELCH

PARTS LIST

MAIN CHASSIS

Symbol No.	Parts No.	Description	
		DIODE	
D01	G2090001	Silicon	10D1
D02	G2090138	"	ERA81-004
D05	G2090139	Zener	WZ-051
		RESISTOR	
R04	J10246101	Carbon Composition	1/4W 100Ω
R02	J01245681	Carbon Film	1/8W 680Ω
R03	J20336390	Metallic Film	2W 39Ω
		POTENTIOMETER	
VR01	J60800063	V12M4-1(6x5)S(SJ)	5kΩB
VR02(with S01)	J60800032	V12M4-1(6x5)S15SA	20kΩA
		CAPACITOR	
C01	K00179005	Ceramic Disc	50WV SL 20pF
C02,03,07,09	K10179001	" "	" 0.001μF
C06	K70107107	Tantalum	10WV 100μF
C05,08,10	K40109001	Electrolytic	" 100μF
C04	K40129009	"	16WV 220μF
		INDUCTOR	
L01	L0020334		
		SPEAKER	
SP01	M4090028	8Ω 0.5W	VS-50Y
		MICROPHONE	
M01	M3290001		EM-76
		SWITCH	
S01(with VR02)	-		
S03	N6090007		SSS-013
S04,05,06	N6090008		SSS-012
S07	N0190017A		BQ919-00805C
S08	N5090001		KEA5A007
S09	N6090006		SST-12.04V
		CONNECTOR	
J01	P1090089		FM10RS-6H
J02	P1090113		UG-625B/U
J03	P1090005		SG-8050
J04	P1090095		SG-8512

		PLUG
P01	T9202410	5248-08 with wire
MAIN UNIT		
Symbol No.	Parts No.	Description
	C0020600	P.C.B with Component
PB-2060C	F0002060C	Printed Circuit Board
		IC-FET-TRANSISTOR
Q204,205,302	G4800510C	FET 3SK51-03
Q301	G3800190G	" 2SK19GR
Q303	G3801680D	" 2SK168D
Q107,109,212	G3106950D	Tr 2SA695D
Q309	G3304580D	" 2SC458D
Q304,308	G3305351	" 2SC535A
Q108,213	G3312090D	" 2SC1209D
Q103,110,203, 209,210,211	G3313110E	" 2SC1311E
Q105,111,305, 306	G3318150Y	" 2SC1815Y
Q106	G3318150G	" 2SC1815GR
Q101,206	G3320260	" 2SC2026
Q208	G3321960	" 2SC2196
Q102	G3323520	" 2SC2352
Q207	G3324070	" 2SC2407
Q202	G1090120	IC 78L05
Q104	G1090145	" MC3357
Q201	G1090072	" μ PC577H
Q214*	G1090239	" TC-5082P
Q307	G1090237	" μ PD2819C
		DIODE
D101,105	G2090033	Silicon MI-301
D102,207~211	G2015550	" 1S1555
D302,303,304	G2090027	" 1SS53
D103	G2090007	Zener RD6.8EB
D305	G2090049	" WZ056
D301	G2090107	Varactor 1T25
D201	G2090108	" 1SV68
D203~206	G2090109	" 1SV69
D104	G9090007	Varistor MV-12
D202	G9090005	" MV-103

		SWITCH			
S101	N7090021				AH1212
		CRYSTAL			
X101	H0100920	HC-45/UT			10.245MHz
X201	H0101988	HC-18T/U			10.7MHz
X202*	H0101982	"			7.168MHz
X301	H0101986	"			5.76MHz
X301*	H0101987	"			7.2MHz
X302	H0101984	"			44.1MHz
X302*	H0101989	"			44.0166MHz
X303	H0101985	"			44.10166MHz
		(* EUROPE MODEL)			
		FILTER			
XF101,102	H1102013	FMT-15B			
CF101	H3900171	CFG-455E1			
CF201	H3900211	10.7MF-18			
		RESISTOR			
R141,142	J10246229	Carbon Composition		1/4W	2.2Ω
R226	J10246100	" "		"	10Ω
	J10246150	" "		"	15Ω
R143,233,251	J10246220	" "		"	22Ω
R229	J10246330	" "		"	33Ω
R341	J10246470	" "		"	47Ω
R136,206	J10246560	" "		"	56Ω
R106,111,117, 138,219,302, 303,308,323	J10246101	" "		"	100Ω
R140,318	J10246151	" "		"	150Ω
R139,217,307	J10246221	" "		"	220Ω
R232	J10246271	" "		"	270Ω
R227	J10246331	" "		"	330Ω
R213,324,245*	J10246471	" "		"	470Ω
R204	J10246561	" "		"	560Ω
R311	J10246821	" "		"	820Ω
R101,126,135, 150,317,335	J10246102	" "		"	1kΩ
R118,121,129, 338	J10246152	" "		"	1.5kΩ
R231,334	J10246182	" "		"	1.8kΩ
R105,109,115, 120,122,137, 202,242,314, 319	J10246222	" "		"	2.2kΩ
R244	J10246272	" "		"	2.7kΩ
R201,228,328, 329	J10246332	" "		"	3.3kΩ

R315,321	J10246392	" "	"	3.9kΩ
R337	J10246472	" "	"	4.7kΩ
R210	J10246562	" "	"	5.6kΩ
R110,112,131, 132,240,243, 339,340	J10246103	" "	"	10kΩ
R130	J10246153	" "	"	15kΩ
	J10246183	" "	"	18kΩ
R147,207,211, 326,330,331, 332	J10246223	" "	"	22kΩ
R103,107,114, 208,336	J10246333	" "	"	33kΩ
R313	J10246393	" "	"	39kΩ
R124,146,212, 305,306,325	J10246473	" "	"	47kΩ
R123	J10246513	" "	"	51kΩ
R104,113,125, 320	J10246823	" "	"	82kΩ
R108,209,223, 241,249*,301, 304,310	J10246104	" "	"	100kΩ
R119,133	J10246224	" "	"	220kΩ
R127,316	J10246274	" "	"	270kΩ
R333	J10246275	" "	"	2.7MΩ
R214	J00215221	Carbon Film	1/8W	220Ω
R234,250	J00215331	" "	"	330Ω
R205,252	J00215102	" "	"	1kΩ
R203	J00215152	" "	"	1.5kΩ
R247	J00215332	" "	"	3.3kΩ
R128	J00215472	" "	"	4.7kΩ
R149,237,248	J00215103	" "	"	10kΩ
R134	J00215183	" "	"	18kΩ
R144,147,238	J00215223	" "	"	22kΩ
R215,216,224, 225,246	J00215473	" "	"	47kΩ
R145,218,222	J00215104	" "	"	100kΩ
		POTENTIOMETER		
VR201	J50705102	EVN-B1AA00B13	1kΩ	
		CAPACITOR		
C228,314	K00179049	Ceramic Disc	50WV SL	0.5pF
C104,110	K00179024	" "	" "	1pF
C316	K00179025	" "	" "	2pF
C312	K00179026	" "	" "	3pF
C113,116	K00179052	" "	" "	4pF
C216,232	K02179053	" "	" CH	4pF
C344	K06179027	" "	" UJ	4pF

C306	K00179027	"	"	"	SL	5pF
C223,225,229	K02179052	"	"	"	CH	5pF
C222,227,230, 233	K06179030	"	"	"	UJ	7pF
C105,108,111, 231,310	K00179029	"	"	"	SL	8pF
C303	K06179031	"	"	"	UJ	8pF
C128,328,329	K00179031	"	"	"	SL	10pF
C226,323	K00179045	"	"	"	"	12pF
C276	K02179040	"	"	"	CH	12pF
C103,249,258*	K00179032	"	"	"	SL	15pF
C234,250	K00179033	"	"	"	"	22pF
C302	K06179037	"	"	"	UJ	22pF
C239,240,244, 253	K00179040	"	"	"	SL	27pF
C102,106,245, 332,333	K00175330	"	"	"	"	33pF
C326	K02179035	"	"	"	CH	33pF
C301	K06179021	"	"	"	UJ	33pF
C254~256	K00179041	"	"	"	SL	39pF
C123	K00179038	"	"	"	"	47pF
C322	K00179051	"	"	"	"	68pF
C215	K06179023	"	"	"	UJ	56pF
C259*,260*	K02179049	"	"	"	CH	100pF
C124	K00179050	"	"	"	SL	120pF
C101	K10179003	"	"	"		470pF
C107,109,112, 114,115,117, 120,132,133, 137,145,148, 149,214,221, 224,235~237, 241~243,246, 247,251,252, 257,261,262, 265~268, 270~272,275, 276,304, 307~309,313, 319,324,327, 336,339,340, 343,347	K10179001	"	"	"		0.001 μ F
C118,119,121, 125,141,220, 263*,264*, 315,317,318, 320,321,325	K13179001	"	"	"		0.01 μ F

C122,126,127	K13179002	“ “	“	0.022 μ F
C217,218	K51176101	Styrol	50WV	100pF
C134,135	K70160002	Tantalum	35WV	0.022 μ F
C203,348	K70160001	“	“	0.047 μ F
C131,144	K70167104	“	“	0.1 μ F
C201	K70167154	“	“	0.15 μ F
C334	K70167474	“	16WV	0.47 μ F
C136,138,147, 213,337,338	K70147105	“	25WV	1 μ F
C130,269	K70127475	“	16WV	4.7 μ F
C129,139,202, 205~210,248, 305,330,331,	K70127106	“	“	10 μ F
C140,142,143	K70127476	“	“	47 μ F
C211,212,341, 342	K19149021	UAT08x473K-L46AE		0.047 μ F
C146	K40129007	Electrolytic	“	100 μ F
C346	K40109001	“	10WV	100 μ F
C273,274	K23140002	Ceramic chip	25WV	18000pF
		TRIMMER CAPACITOR		
TC201,301,302	K91000029	ECV-1ZW20x53	20pF	
		INDUCTOR		
L302	L1190004	FL4HR68M		0.68 μ H
L306,308	L1190014	FL4H100K		10 μ H
L304	L1190015	FL5H120J		12 μ H
L101	L0020341			
L301	L0020742			
L203,204,205, 206,212	L0020744			
L307	L0020745			
L202	L0020775			
L207,213,214	L0020748			
L208	L0020766			
L201	L1190102	S-104K		100mH
L303	L1020016	RFC		
L209,210,305	L1020469	“		
L211	L1020662	“		
		TRANSFORMER		
T101~104, 201~204, 301,302	L0020747	210SN-128N		
T105~107	L0020477	86AC-600N		
T108	L0020478	MMC-586N		
	R0056160	Heat Sink		

CONTROL UNIT

Symbol No.	Parts No.	Description		
	C0020610	P.C.B with Component		
PB-2061B	F0002060B	Printed Circuit Board		
		IC & TRANSISTOR		
Q401	G1090233	IC	μ PD650-C-42	
Q402	G1090094	"	MC1413	
Q404	G1090127	"	MC14410	
Q403	G1090105	"	μ PA56C	
Q407	G3406360R	Tr	2SD636-R	
Q405,406	G3090031	"	JA1350G	
		DIODE		
D401~407,409, 414~417	G2015550	Silicon	1S1555	
D410	G2090070	LED	LN222RP	
D411	G2090071	"	LN322GP	
D412	G2090049	Zener	WZ056	
D413	G2090111	"	HZ6C-1	
		DISPLAY LED		
DS401	G2090110		5082-7415	
		CRYSTAL		
X401	H0101200	HC-43/UT	1MHz	
		CERAMIC		
CO401	H7900070		CSB-400A	
		BLOCK RESISTOR		
R401	J40900003	(R401-R407)	RA7R	100k Ω
R408	J40900009	(R408-R413)	RA6R	100k Ω
		RESISTOR		
	J00215100	Carbon Film	1/8W	10 Ω
R414~420,429	J00215221	" "	"	220 Ω
R421	J00215331	" "	"	330 Ω
R427	J00215821	" "	"	820 Ω
R430	J00215102	" "	"	1k Ω
R422,424	J00215103	" "	"	10k Ω
R426	J10246473	" "	"	47k Ω
R431,432	J00215513	" "	"	51k Ω
R423,428	J00215104	" "	"	100k Ω
	J00215154	" "	"	150k Ω
R433	J10246275	Carbon Composition		2.7M Ω

		CAPACITOR		
C405,406	K00179038	Ceramic Disc	50WV SL	47pF
C403,407~409, 411	K10179001	" "	"	0.001μF
C401	K70147105	Tantalum	25WV	1μF
C404	K70127225	"	16WV	2.2μF
C402	K70127475	"	"	4.7μF
C408	K40109001	Electrolytic	10WV	100μF
		IC SOCKET		
	P3090032		DIP	14P
ACCESSORIES				
Symbol No.	Parts No.	Description		
	Q3000005	Antenna	YHA-14	
	Q9000031	Battery Pack	NBP-9	
	Q9000071	Battery Charger	NC-9B (117VAC)	
	Q9000072	" "	NC-9C (220-234VAC)	
	M4190001	Ear Phone		
TONE SQUELCH UNIT (OPTION)				
Symbol No.	Parts No.	Description		
	C0020620	P.C.B with Components (without Q501, R501, R502)		
	F0002062	Printed Circuit Board		
		IC & TRANSISTOR		
Q501	G1090178	IC	86022	
Q502~505	G3313110E	Tr	2SC1311E	
		DIODE		
D501	G2090125	Zener	HZ9A-1	
		RESISTOR		
R507	J00245102	Carbon Film	1/4W	1kΩ
R505,506	J00245103	" "	"	10kΩ
R503	J01245103	" "	" TJ	10kΩ
R508	J00245104	" "	"	100kΩ
TUNING RESISTOR (SEE PAGE 27)				
R501(67.0Hz)	J20249065	Carbon Film	1/4W	180kΩ
R502(" ")	J20249098	" "	"	442Ω
R501(71.9Hz)	J20249066	Carbon Film	1/4W	154kΩ
R502(" ")	J20249099	" "	"	2.67kΩ
R501(77.0Hz)	J20249064	Carbon Film	1/4W	133kΩ
R502(" ")	J20249100	" "	"	3.65kΩ
R501(82.5Hz)	J20249067	Carbon Film	1/4W	118kΩ
R502(" ")	J20249101	" "	"	1kΩ

R501(88.5Hz)	J20249068	Carbon Film	1/4W	102kΩ
R502(" ")	J20249102	" "	"	1.43kΩ
R501(94.8Hz)	J20249069	Carbon Film	1/4W	88.7kΩ
R502(" ")	J20249102	" "	"	1.43kΩ
R501(100.0Hz)	J20249070	Carbon Film	1/4W	80.6kΩ
R502(" ")	J20249103	" "	"	402Ω
R501(103.5Hz)	J20249071	Carbon Film	1/4W	75kΩ
R502(" ")	J20249104	" "	"	619Ω
R501(107.2Hz)	J20249072	Carbon Film	1/4W	69.8kΩ
R502(" ")	J20249105	" "	"	681Ω
R501(110.9Hz)	J20249073	Carbon Film	1/4W	64.9kΩ
R502(" ")	J20249106	" "	"	953Ω
R501(114.8Hz)	J20249074	Carbon Film	1/4W	60.4kΩ
R502(" ")	J20249107	" "	"	1.07kΩ
R501(118.8Hz)	J20249075	Carbon Film	1/4W	56.2kΩ
R502(" ")	J20249111	" "	"	1.2kΩ
R501(123.0Hz)	J20249076	Carbon Film	1/4W	52.3kΩ
R502(" ")	J20249108	" "	"	1.24kΩ
R501(127.3Hz)	J20249077	Carbon Film	1/4W	196kΩ
R502(" ")	J20249109	" "	"	3.92kΩ
R501(131.8Hz)	J20249078	Carbon Film	1/4W	182kΩ
R502(" ")	J20249110	" "	"	4.53kΩ
R501(136.5Hz)	J20249079	Carbon Film	1/4W	169kΩ
R502(" ")	J20249112	" "	"	4.87kΩ
R501(141.3Hz)	J20249080	Carbon Film	1/4W	162kΩ
R502(" ")	J20249113	" "	"	280Ω
R501(146.2Hz)	J20249081	Carbon Film	1/4W	150kΩ
R502(" ")	J20249114	" "	"	1.58kΩ
R501(151.4Hz)	J20249082	Carbon Film	1/4W	140kΩ
R502(" ")	J20249115	" "	"	1.33kΩ
R501(156.7Hz)	J20249083	Carbon Film	1/4W	130kΩ
R502(" ")	J20249116	" "	"	1.96kΩ

R501(162.2Hz)	J20249084	Carbon Film	1/4W	121k Ω
R502(" ")	J20249117	" "	"	2.15k Ω
R501(167.9Hz)	J20249085	Carbon Film	1/4W	113k Ω
R502(" ")	J20249118	" "	"	1.91k Ω
R501(173.8Hz)	J20249086	Carbon Film	1/4W	107k Ω
R502(" ")	J20249119	" "	"	261 Ω
R501(179.9Hz)	J20249087	Carbon Film	1/4W	100k Ω
R502(" ")	J20249120	" "	"	110 Ω
R501(186.2Hz)	J20249088	Carbon Film	1/4W	93.1k Ω
R502(" ")	J20249121	" "	"	348 Ω
R501(192.8Hz)	J20249089	Carbon Film	1/4W	86.6k Ω
R502(" ")	J20249122	" "	"	562 Ω
R501(203.5Hz)	J20249090	Carbon Film	1/4W	76.8k Ω
R502(" ")	J20249102	" "	"	1.43k Ω
R501(210.7Hz)	J20249091	Carbon Film	1/4W	71.5k Ω
R502(" ")	J20249124	" "	"	1.47k Ω
R501(218.1Hz)	J20249092	Carbon Film	1/4W	68.1k Ω
R502(" ")	J20249125	" "	"	13 Ω
R501(225.7Hz)	J20249093	Carbon Film	1/4W	63.4k Ω
R502(" ")	J20249126	" "	"	200 Ω
R501(233.6Hz)	J20249094	Carbon Film	1/4W	59k Ω
R502(" ")	J20249127	" "	"	374 Ω
R501(241.8Hz)	J20249095	Carbon Film	1/4W	54.9k Ω
R502(" ")	J20249128	" "	"	511 Ω
R501(250.3Hz)	J20249096	Carbon Film	1/4W	51.1k Ω
R502(" ")	J20249129	" "	"	619 Ω
		POTENTIOMETER		
VR501	J51729103			RV8-FAN-10k Ω
VR502	J51729203			RV8-FAN-20k Ω
		CAPACITOR		
C503	K70167105	Tantalum	35WV	1 μ F
C501,502,504, 505	K70127106	"	16WV	10 μ F
J501	P0090037	CONNECTOR		#5048-08A

IMPORTANT NOTE

Your Yaesu equipment is backed by a warranty that guarantees your set to be free of defects. Take a few minutes to read the warranty card carefully. Make certain that you fill out the card completely, and mail it at once, in order to qualify for warranty service.

Warranty service is to be performed by the dealer from whom the equipment was purchased. Do not return the equipment to Yaesu for servicing without first getting a service authorization from the Yaesu Service Center. Estimates of the approximate cost to repair are available upon request.



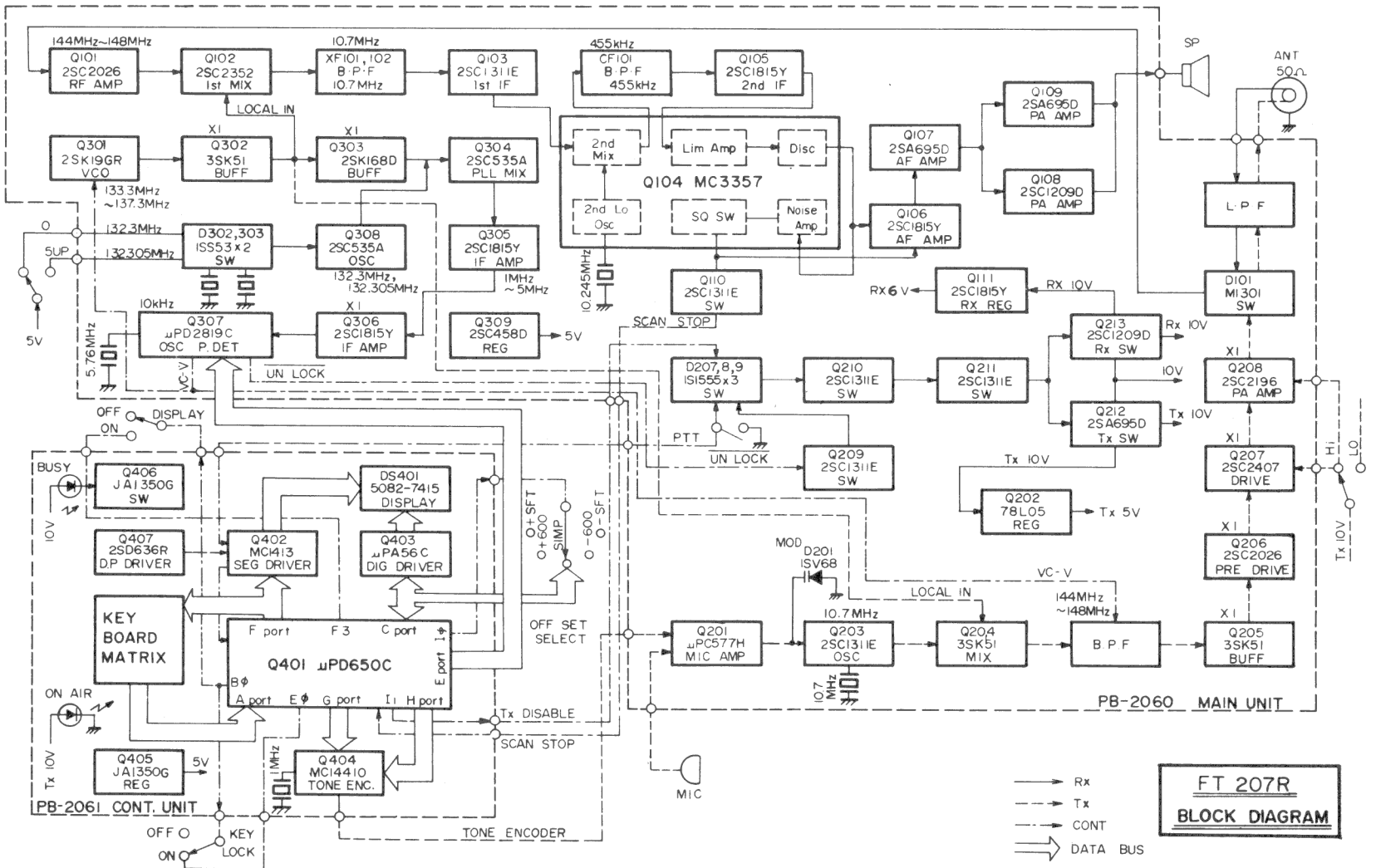

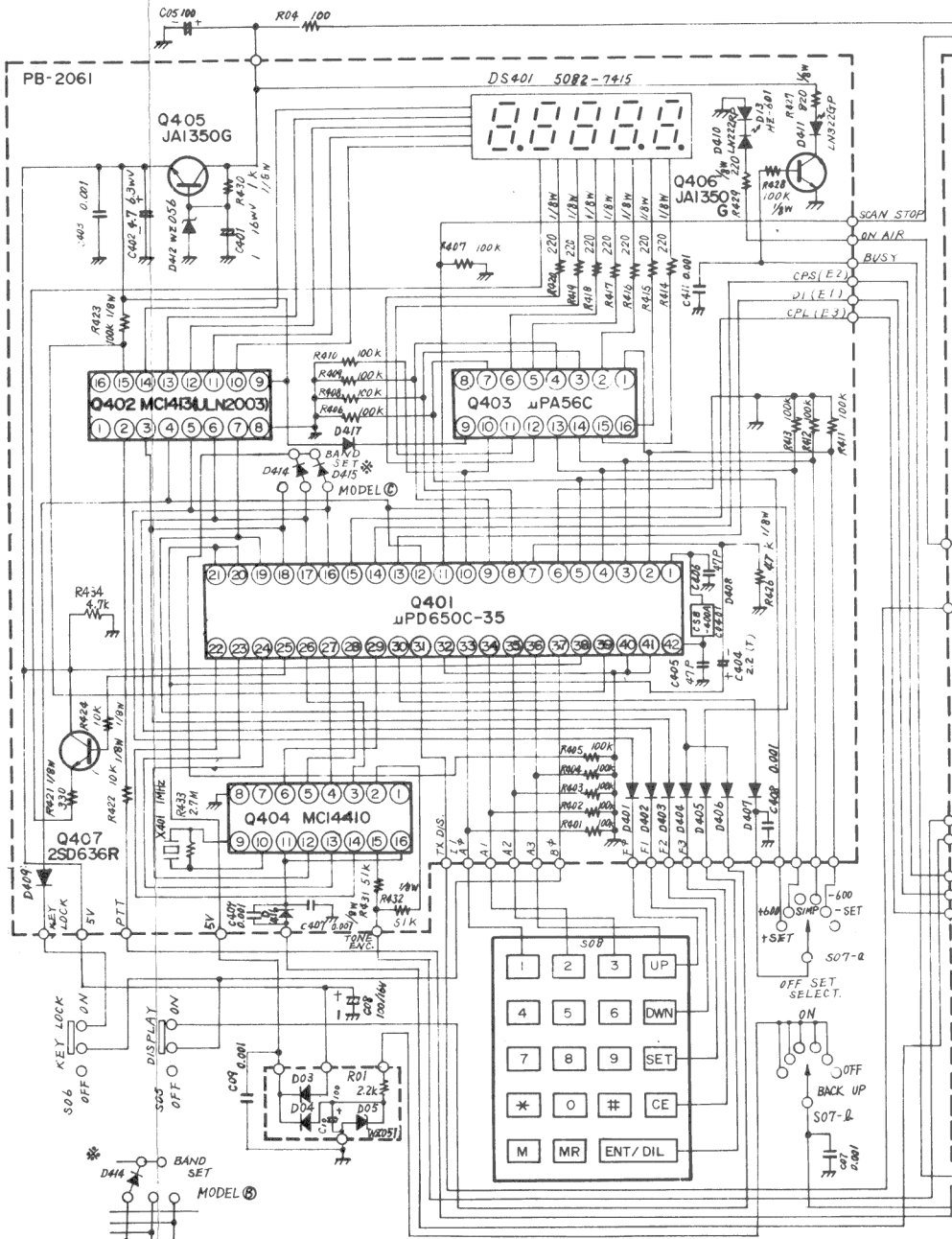

13 17 16
Q401

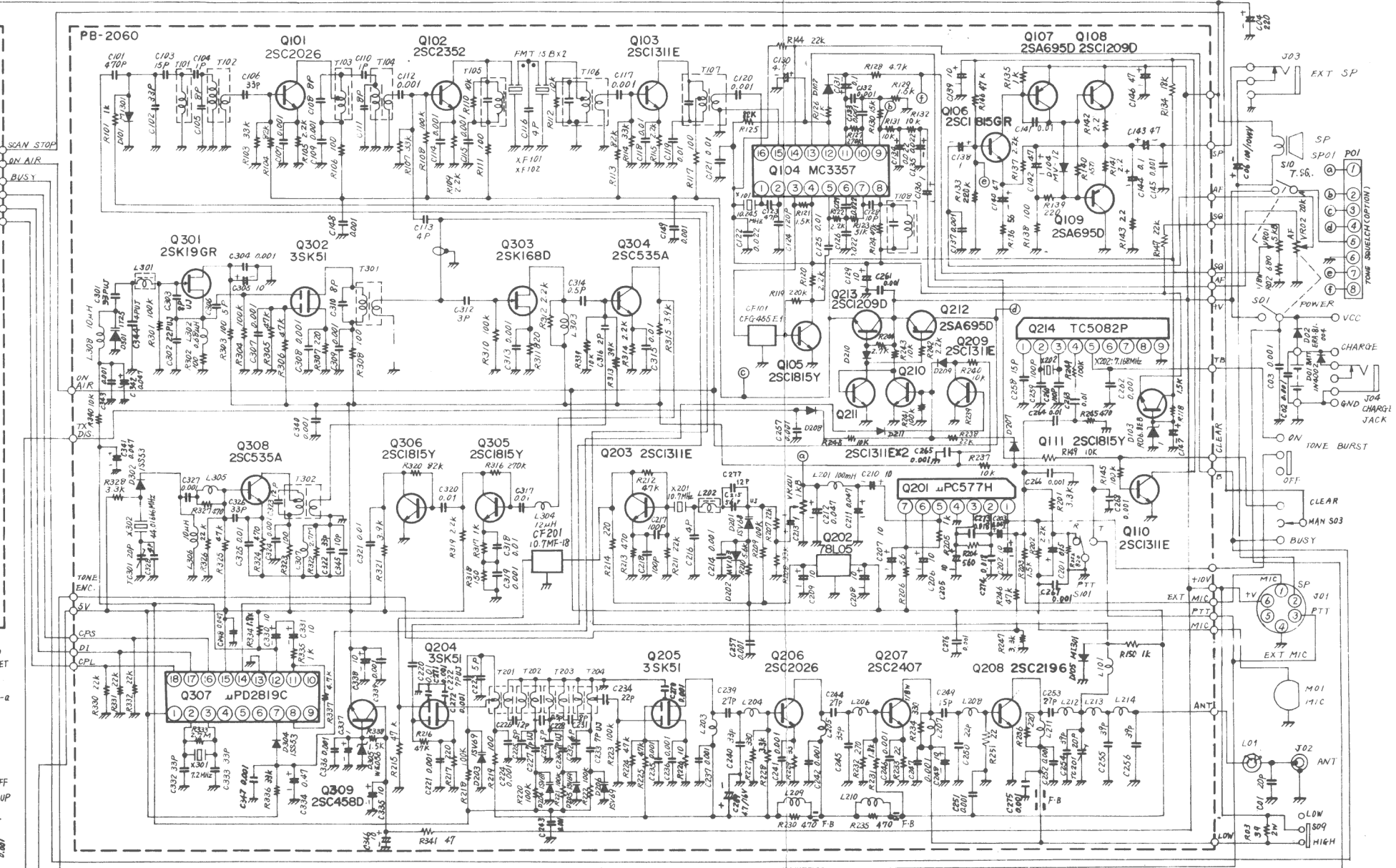

NOTES

1. ALL RESISTORS ARE IN 14W UNLESS OTHERWISE NOTED.
2. ALL CAPACITORS ARE IN μF UNLESS OTHERWISE NOTED.

3. ALL ELECTROLYTIC CAPACITORS ARE 16WV UNLESS OTHERWISE NOTED.
4. ALL DIODES ARE 1N4001 UNLESS OTHERWISE NOTED.
5. VALUE IS NOMINAL.

FT - 207R
 MODEL B(C)
CIRCUIT DIAGRAM